



PORTABLE FOODWARMERS



CHOICES

THROUGH CUSTOMERIZATION

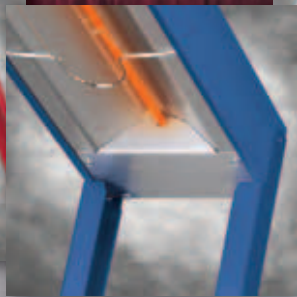

Unique Needs, Exact Solutions.



SERV-RITE™

PORTABLE BUFFET WARMERS

OPTIMUM SERVING TEMPERATURES, UNCOMPROMISING QUALITY

The Hatco Serv-Rite™ Portable Buffet Warmers are designed to keep prepared foods at optimum serving temperatures without affecting quality. They're perfect for self-serve buffet areas and customer serving points. All Serv-Rite Buffet Warmers feature a thermostatically controlled heated base, durable stainless steel construction, sturdy aluminum extrusions, and a 6' (1829 mm) cord with plug.

Hatco Serv-Rite Buffet Warmers are ideal for use in buffet lines and as hors d'oeuvre displays. These unique foodwarmers are available with or without overhead halogen heat lamps and glass sneeze guards. The Choice is Yours.

- All models equipped with removable utensil tray
- Digital temperature control
- SRBW and SRGBW models have top light and heat variably controlled from a base mounted dimmer switch

See Page 5 for Serv-Rite Heated Shelf models.

800.558.0607
www.hatcocorp.com



*SRBW-1 with halogen lights
and glass sneeze guard*



*SRGBW-1 with heated
black glass inset, halogen
lights and glass sneeze guard*



BLACK GLASS

HEATED CERAMIC GLASS SURFACE

THE MARRIAGE OF UNIFORM HEAT AND DIRECT FOOD PLACEMENT

The Hatco Heated Black Glass Shelf surface color is an elegant black, to add the right touch to any décor. Thermostatically-controlled heated ceramic glass surface helps hold your food hot and delicious at a surface temperature ranging from 100° to 200°F (38°-93°C). Place food product directly on the ceramic glass surface. The Heated Black Glass Shelf excels in pass-through areas, buffet lines and as a tempting hors d'oeuvre display. The Choice is Yours.

- Available in portable and built-in models
- Lighted on/off rocker switch
- Portable units are available with accessory trim rings and handles in stainless steel (standard) or powdercoated *Designer Black*
- All units come with a 6' (1829 mm) cord and plug

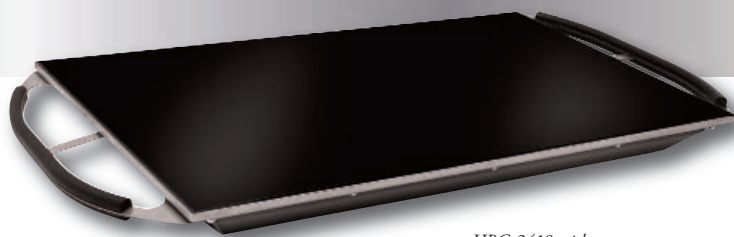

HBG-2418 with accessory handles



HBG-2418

Unique Needs, Exact Solutions.





HEATED SHELVES

HEATING TECHNOLOGY FOR EVERY APPLICATION



GRAH-30 with optional Designer color and infinite switch and accessory C-leg stand over Heated Shelf GRS-24-1 in optional Designer color, with accessory food pans

TWICE AS EFFECTIVE, SAME HATCO QUALITY

Depending on your foodservice layout, your product could benefit from a more effective arrangement: heat from above and below. Now there's no need to worry about drying out foods or cooking beyond the desired stage when you entrust your product to Hatco's Glo-Ray® line of foodwarmers. They're portable, flexible, and available in a variety of arrangements. Let Glo-Ray technology work for you.

DESIGNER COLORS



Printed colors are a representation and may not exactly match our Designer Colors.

GRSR-17 with optional Designer color and accessory food pan



800.558.0607
www.hatcocorp.com



SRG-1 with black glass inset and food pans



SRB-1 with standard full-size food pan

SERV-RITE™ HEATED SHELVES (NOT AVAILABLE IN DESIGNER COLORS)

FITS JUST RIGHT

Simplicity and functionality team up in Hatco's Glo-Ray® Portable, Designer, Drop-in, and Round Heated Shelves. Whether you need a heated workspace or extra base heat in a pass-through or buffet area, Hatco's full line of shelf options can help you. Using a blanket or metal-sheathed heating element for an even temperature, the thermostatically controlled base extends the holding time of your food. Made with durable stainless steel, hardcoated aluminum, or ceramic black glass tops. Hatco Heated Shelves are available in a broad selection of sizes to fit your operation. If bottom heat is what you need, then Hatco has it. The Choice is Yours.



GRSSR-16 in Night Sky Decorative Stone with optional 3" (76 mm) Riser in Designer color

GRSSR-18 in Night Sky Decorative Stone with optional 5" (127mm) Riser in Designer color

GRSSR-20 in Night Sky Decorative Stone

GLO-RAY® HEATED STONE SHELVES

Match the heat zone to your countertops with Hatco's Glo-Ray Heated Stone Shelves. The built-in or portable food-safe shelves come in four standard colors and are ideal for buffet lines or as hors d'oeuvre displays. These unique warmers will safely hold food hot while blending in with your décor.



GRSSR20-DL77516 in Night Sky Decorative Stone with accessory curved Swanstone® Night Sky Cutting Board

- Hatco Heated Stone Shelves are made of NSF-approved foodsafe materials
- GRSS models available with accessory handles in stainless steel (standard) or powdercoated Designer Black
- Features a lighted rocker switch and thermostatically-controlled heated base to help hold your food hot and delicious
- GRSSB models include a remote box with a 3' (914 mm) conduit and 6' (1829 mm) cord and plug
- Accessory 3" or 5" (76 mm or 127 mm) Risers available (GRSSR models only) in stainless steel (standard) or Designer colors

HEATED STONE COLORS

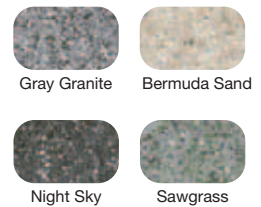

Printed colors are a representation and may not exactly match our Heated Stone Colors.



GRSS-3618 in Bermuda Sand Decorative Stone with accessory handles

Unique Needs, Exact Solutions.





ULTRA-GLO®

PORTABLE FOODWARMERS

ULTIMATE HEAT SOURCE

FOOD ACCESS, WITH NO TEMPERATURE SACRIFICE

Think flexible working space and quality heat. Take a closer look at Hatco's Ultra-Glo® Portable Foodwarmers. They're designed to provide more distance between the heat source and the holding pan than most foodwarmers, while maintaining even heat from above, below, or both. The Ultra-Glo line was created with customerization in mind. A wide selection of styles, colors, lights, controls, hardcoated fry ribbons, pans, and trivets can mean only one thing... The Choice is Yours.



UGFFL in optional gloss finish with accessory fry ribbon and food pan



GRCSCCL-24 with optional sneeze guards, drip pan, and cutting board (not available in other colors or finishes)

DESIGNER COLORS

- | | | | |
|-----------|--------------|----------------|---------------|
| | | | |
| Warm Red | Black | Gray Granite | White Granite |
| | | | |
| Navy Blue | Hunter Green | Antique Copper | |

Printed colors are a representation and may not exactly match our Designer Colors and Gloss Finishes.

GLOSS FINISHES

- | | | | | |
|-------------|---------------|-------------|----------------|------------|
| | | | | |
| Radiant Red | Gleaming Gold | Glossy Gray | Brilliant Blue | Bold Black |

800.558.0607
www.hatcocorp.com



GLO-RAY® PORTABLE FOODWARMERS

WHEREVER YOU NEED IT, HEAT IT

CHOOSE YOUR SOLUTION

You can take it with you when you opt for the versatility of Hatco's Glo-Ray® Portable Foodwarmers. Need heat from above, below, or both? We've got it! Hatco's foodwarmers offer design flexibility without sacrificing food product quality. The optional sign holder helps generate impulse sales. The complete Glo-Ray line has the solution for your foodwarming need, and the design capabilities to match a product to your specifications. The Choice is Yours.

- Portable – ready to plug and “GLO”
- Each unit comes with a factory attached 6' (1829 mm) cord and plug so you can put heat where you need it
- Versatile – available in many sizes, styles, and heat sources to fit your needs
- Flexible – both top and thermostatically controlled bottom heat available
- Accessories to customize foodwarmers to any setting and application



GR-B Heated Base with accessory sheet pan

GRFFB with optional infinite switch and accessory food pans



TRADITIONAL WARMERS – EXCEPTIONAL PERFORMANCE

It's easy to find a portable Hatco foodwarmer for your application. The Glo-Ray portable foodwarmer displays your product while keeping it hot and fresh. The Hatco Lamp Warmer has a specially designed, adjustable stand, and unique insulating base to extended holding time. Available in seven *Designer* colors, they're an updated version of classic designs that have served operators for years.



LW-2 Lamp Warmer with optional Designer color and accessory food pans

Unique Needs, Exact Solutions.



SPECIFICATIONS

PLEASE REFERENCE PRODUCT SPECIFICATION SHEETS FOR INDIVIDUAL MODEL LISTINGS

SERV-RITE™ BUFFET WARMERS AND HEATED SHELVES

Models SRB-1, SRBW-1, SRG-1, SRGBW-1
Available in 120 volts, single phase.

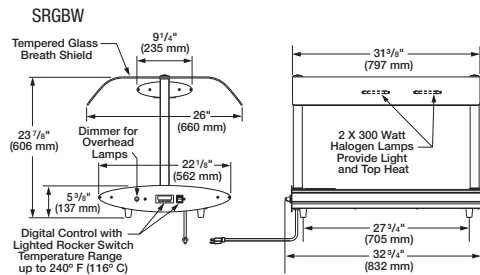
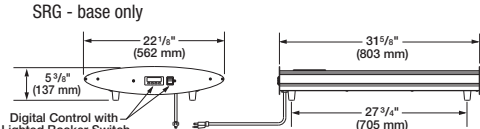
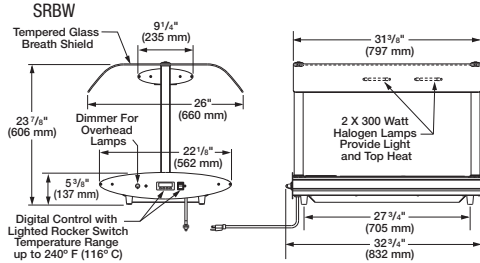
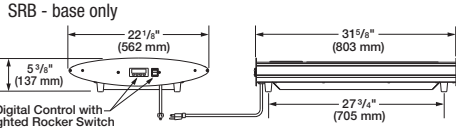

BLACK GLASS HEATED SHELVES

Models HBG-2418, -3018, -3618, -4818, -6018, -7218
Heated Black Glass Shelf
Available in 120 volts, single phase only.

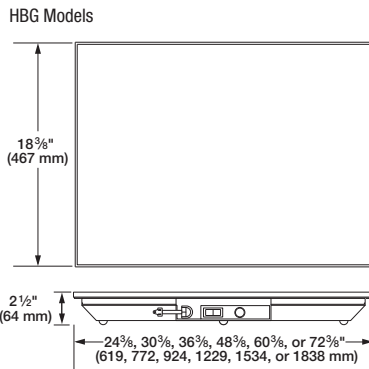

HEATED SHELVES

Glo-Ray® Model GR2S Designer Heated Shelf

Available in 120 volts, single phase, and seven *Designer* colors.

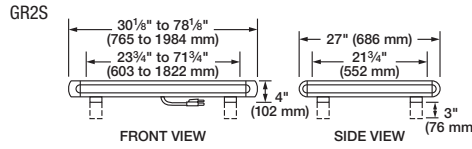

Glo-Ray® Model GRS Heated Shelf

Available in 120 volts, single phase, and seven *Designer* colors.

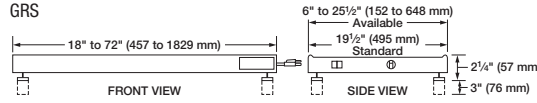

Glo-Ray® Model GRSR Round Heated Shelf

Available in 120 volts, single phase, and seven *Designer* colors.

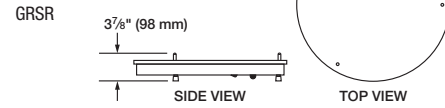

Glo-Ray® Model GRSS Portable Heated Stone Shelf

Available in 120 volts, single phase, top in four *Decorative Stone* colors with base available in seven *Designer* colors.

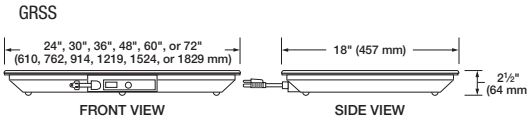

Glo-Ray® Model GRSSR Round Heated Stone Shelf

Available in 120 volts, single phase, top in four *Decorative Stone* colors with base available in seven *Designer* colors.

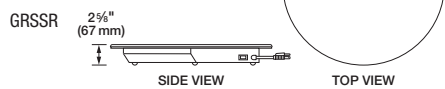

Glo-Ray® Model GRSSR20-DL77516

Heated Stone Shelf with Decorative Lamp

Available in 120 volts, single phase, top in four *Decorative Stone* colors with lamp and base available in seven *Designer* colors.

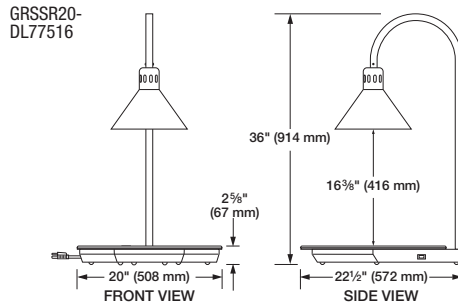

Unique Needs, Exact Solutions.

At Hatco we look, listen, and bring our full experience to your operation. "Customerization" is our brand promise...providing you with foodservice innovations that build your profits. That's Hatco, and that's always good for business. **Contact us today for all of your foodservice equipment needs.**

ULTRA-GLO® PORTABLE FOODWARMERS

Models UGFF, UGFFL, UGFFB, and UGFFBL
Portable Foodwarmers with Ceramic Elements
Available in 120 volts, single phase, and seven *Designer* Colors and five Gloss finishes.

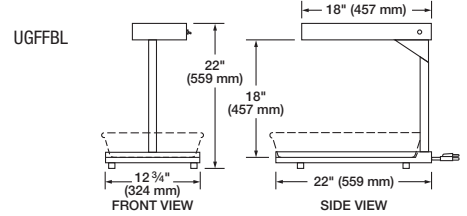

GLO-RAY® CARVING STATIONS

Models GRCSCL-24 and GRCSCLH-24 (with Base Heat)
Carving Stations

Available in 120 volts, single phase (not available in *Designer* Colors and Gloss Finishes).

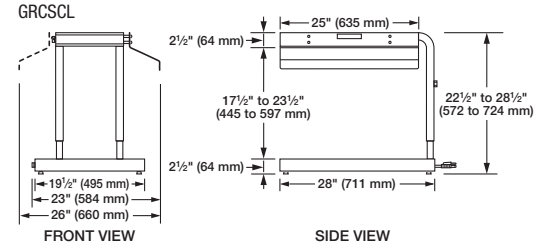

GLO-RAY® PORTABLE FOODWARMERS

Models GRFF, GRFFL, GRFFB, and GRFFBL **Portable Foodwarmers with Metal-Sheathed Elements**

Available in 120 volts, single phase, and seven *Designer* colors and five Gloss finishes (excludes heated base).

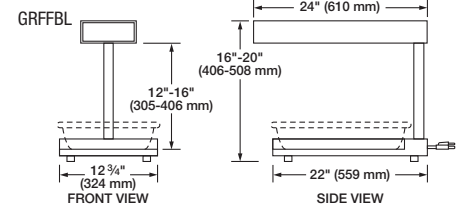
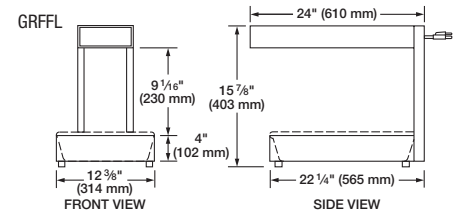

PORTABLE LAMP WARMER

Model LW-2 Portable Lamp Warmer

Available in 120 volts, single phase, and seven *Designer* colors.

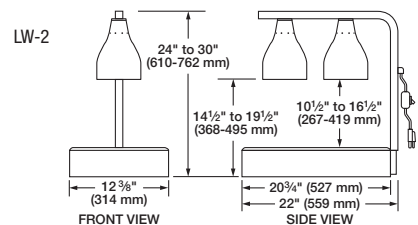

Nothing less than the best.™

P.O. Box 340500
Milwaukee, WI 53234-0500 U.S.A.
(800) 558-0607 (414) 671-6350
www.hatcocorp.com
E-mail: equipsales@hatcocorp.com

Printed in U.S.A.

Cover photo and photos appearing on Pages 2-3 taken at the Pfister Hotel, Milwaukee, WI



Form No. PFWB-0408-1 WW-SG
Revised November 2008